



Preliminary

1. GENERAL DESCRIPTION

The EMPCD082 is a single-chip LS1 CMOS calculator for 8-digit 1 memory. Besides, the EMPCD082 is an arithmetic four standard types of general function (+, −, ×, ÷), percentage calculation functions, leading zero and trailing zero suppression, chain calculations, MU calculation, Auto Power OFF available. Dual power supply operation, wide operating voltage, and lower power consumption make it suitable for 1.5 solar battery operated calculator.

2. FEATURES

- Display : 8-digit of data, 1-digit of sign, error, memory load symbol.
- Algebraic mode.
- Standard 4 function (addition, subtraction, multiplication, division).
- Memory calculation.
- Automatic percentage operation with add-on discount.
- Constant calculation.
- Chain calculation.
- Change sign.
- Trailing zero suppression.
- Punction on display, commas for thousands.
- Memory contents indicator, turned on with nonzero in the memory.
- Result overflow, indicating during calculation (most function key are locked as it happened).
- Memory overflow indicating.
- Complementary output buffer for direct driving of liquid crystal display.
- Oscillator/clock generator internal to chip.
- Keyboard encoding internal to chip.
- Automatic power on clear.



Preliminary

- Wide supply voltage range (1.2 to 1.8V).
- Very low power consumption.
- Floating minus.
- Two key roll over available.

3. PIN DESCRIPTIONS

Symbol	I/O	Function
COM1	O	Common 1 to LCD
COM2	O	Common 2 to LCD
COM3	O	Common 3 to LCD
A1	O	O/P Signal to LCD and O/P strobe to lock key
B1	O	O/P Signal to LCD and O/P strobe to lock key
C1	O	O/P Signal to LCD and O/P strobe to lock key
A2	O	O/P Signal to LCD and O/P strobe to lock key
B2	O	O/P Signal to LCD and O/P strobe to lock key
C2	O	O/P Signal to LCD and O/P strobe to lock key
A3	O	O/P Signal to LCD and O/P strobe to lock key
B3	O	O/P Signal to LCD and O/P strobe to lock key
C3	O	O/P Signal to LCD and O/P strobe to lock key
A4	O	O/P Signal to LCD and O/P strobe to lock key
B4	O	O/P Signal to LCD
C4	O	O/P Signal to LCD
A5	O	O/P Signal to LCD
B5	O	O/P Signal to LCD
C5	O	O/P Signal to LCD
A6	O	O/P Signal to LCD
B6	O	O/P Signal to LCD
C6	O	O/P Signal to LCD
A7	O	O/P Signal to LCD
B7	O	O/P Signal to LCD
C7	O	O/P Signal to LCD
A8	O	O/P Signal to LCD
B8	O	O/P Signal to LCD
C8	O	O/P Signal to LCD



Preliminary

Symbol	I/O	Function
S1	O	O/P Signal to LCD
S2	O	O/P Signal to LCD
GND		Ground
VA		Connected as voltage doubler
VB		Connected as voltage doubler
VEE		Connected to capacitor
VDD		Power supply
TS1		Test pin
RESET	I	System reset
K1	O	O/P strobe signal to key
K2	O	O/P strobe signal to key
K3	I/O	O/P strobe signal and key I/P signal
K4	I/O	O/P strobe signal and key I/P signal
K5	I/O	O/P strobe signal and key I/P signal
K6	I/O	O/P strobe signal and key I/P signal
K7	I/O	O/P strobe signal and key I/P signal
K8	I/O	O/P strobe signal and key I/P signal
K9	I	Key I/P signal
K10	I	Key I/P signal
K11	I	Key I/P signal
K12	I	Key I/P signal



Preliminary

4. FUNCTION DESCRIPTIONS

A) OPERATION CHARACTERISTICS

CONSTANT OPERATION

The EMPCD082 has implied constant mode on +, -, X, \div & % operations. The constant is performed automatically by the "=" key, "% " key, or "% " key without a constant for addition, subtraction and division while the first operand is the constant for multiplication.

NUMBER ENTRY

Numericals can be entered up to 8-digit.

MEMORY PROTECTION

In any error detection, the memory contents present before the error detection are protected.

MEMORY INDICATION

If the memory contents are a number other than zero, "M" is indicated in the sign-digit position.

AUTO POWER OFF

If no key is depressed for a specific period of time, the power supply will automatically turn off if the auto power off switch is enable. This time interval up to power-off is 600 sec.

Preliminary

KEY DEFINITION

- Touch Key Constitution

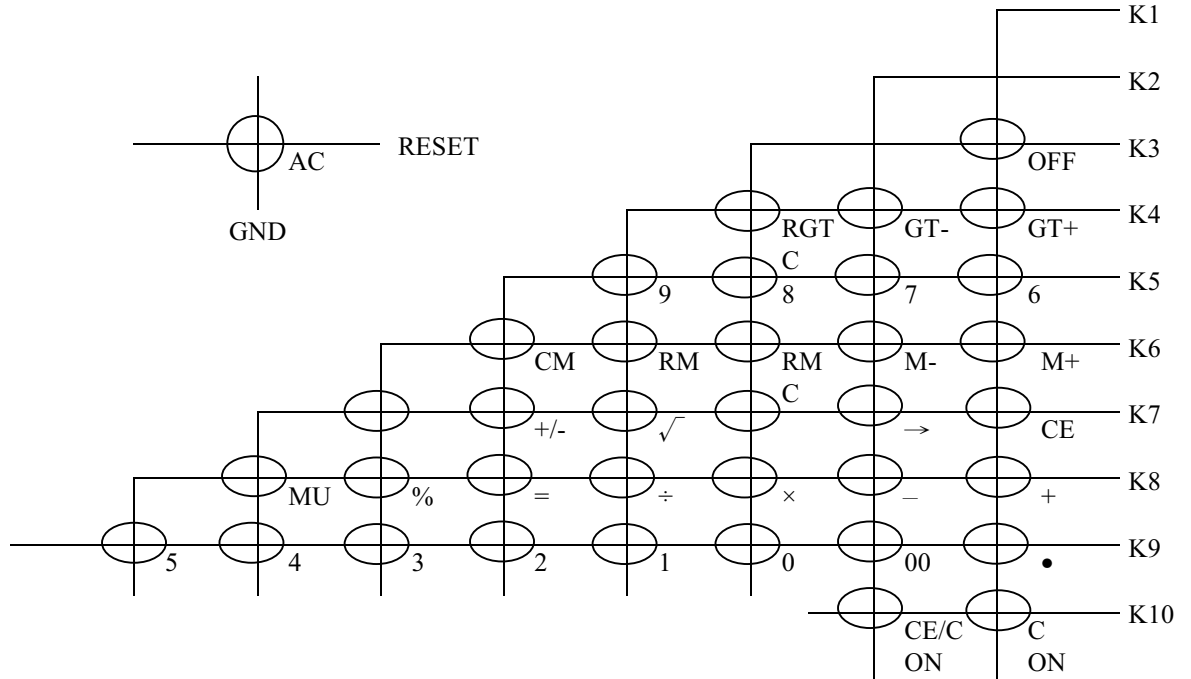

- Lock Key Constitution

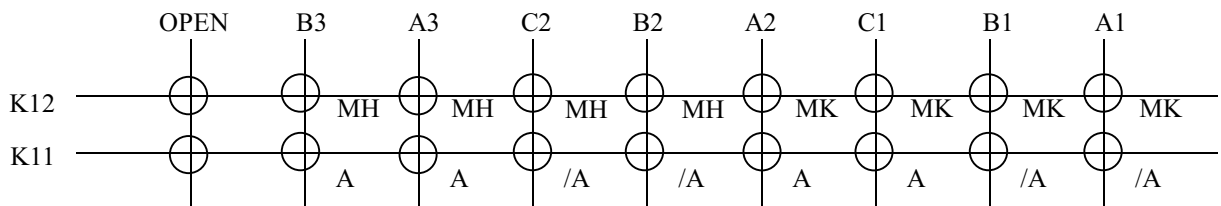

K12 : Select with Calculated Digits and Memory Hold Status, MH (Memory Hold),
 MK (Memory Kill) at Auto Power OFF or OFF key.

K11 : Select with Auto Power OFF mode and total switch.



Preliminary

B) KEYBOARD DESCRIPTION

EQUAL KEY (=)

- Performs Keyed-in operation and maintains that operation for possible use.
- Establishes power/reciprocal calculation.

MULTIPLICATION KEY (X)

- Enters multiplicand.
- Performs previous operation and displays result.

DIVISION KEY (÷)

- Enters dividend.
- Performs previous operation and displays result.

ADDITION KEY (+)

- Conditions machine for an addition.
- Performs previous operation and displays result.

SUBTRACTION KEY (-)

- Conditions machine for a subtraction.
- Performs previous operation and displays result.

PERCENT KEY (%)

The purpose of the percent key is to allow for calculation of add-on and discount. Determination of add-on requires the principal amount to be the first entry followed by the "+" or "X" key, with the percentage being the second entry. Depression of the percent key yields the amount to add on, such as tax or interest. Depression of the "=" key adds this amount to the principal.

CHANGE SIGN KEY (+/-)

Pushing the "+/-" key twice in succession causes the corresponding sign to appear and disappear. During digit entry, this function changes the sign of the entered factor.



Preliminary

CLEAR KEY AND POWER ON KEY (C & ON)

- First push power-on displays "0".
- In the middle of a digit entry, a second push will clear all operating register.

CLEAR ENTRY/CLEAR KEY (CE/C/ON)

- During the digit entry, the first depression will clear the entry register. And display the previous enter number again.
- The second push will clear all registers.

CLEAR ENTRY KEY (CE)

During the digit entry will clear the entry register and display number "0".

SQUARE ROOT KEY ($\sqrt{\quad}$)

Extracts the square root of a positive number displayed in the entry register.

MEMORY PLUS KEY (M+)

- Adds the current display to the contents of memory.
- It will terminate a number entry.

MEMORY MINUS KEY (M-)

- Subtracts the current display from the contents of memory
- It will terminate a number entry.

MEMORY RECALL AND CLEAR KEY (RCM)

- First push, as RM key, transfers the contents of the memory register into the display register.
- Second push, as CM key, clears the memory.

NUMBER, DECIMAL KEY ("00", "0 - 9", "•")

The first number key in a sequence will clear the display and enter the digit in the display. Successive entries will shift the display left and enters the data in display register. The first decimal point entered is effective. An attempted entry of more than 8 digits or 7 decimal places will be ignored.

Preliminary

SHIFT KEY (→)

Delete the rightmost digit and others will shift to right.

MARK-UP KEY (MU)

- Execute add-on calculation by $A (\times) B$ (MU) or discount calculation by $A (\times) B (+/-)$ (MU).
- Execute selling price (mark-up) calculation by $A [/] B [MU]$ or cost (mark-down) calculation by $A [/] B [+/-] [MU]$.
- When intermediate result of addition and subtraction is displayed, execute changing rate calculation, which is increase rate calculation by $A [+] B [-] [MU]$ or growing rate calculation by $A [+] B [+] [MU]$.

C) ERROR CONDITIONS

ERROR DETECTION

System errors occur when :

- The integral part of any calculation result exceeds 8 digits.
- The integral part of any memory calculation result exceeds 8-digit or when the integral part of any addend or subtrahend to memory exceeds 8-digit.
- A division by zero is attempted.

ERROR INDICATION

System error :

- "0" is indicated in the first-digit position and "E" in the sign-digit position.
- The high-order 8-digit of a calculation result is indicated together with "E". The location of the decimal point corresponds to the result of calculation times $1e-8$, and no zero shift is performed.

ERROR RELEASE

System error :

A system error can be released by depressing ON/AC key or CE/C key. However the calculation result is not cleared by CE/C key but is retained.

Preliminary

D) LCD DISPLAY

INTER CONNECTION OF LCD

SEGMENT

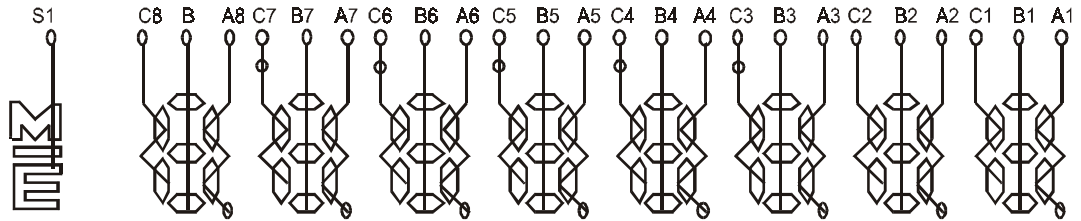

COMMON

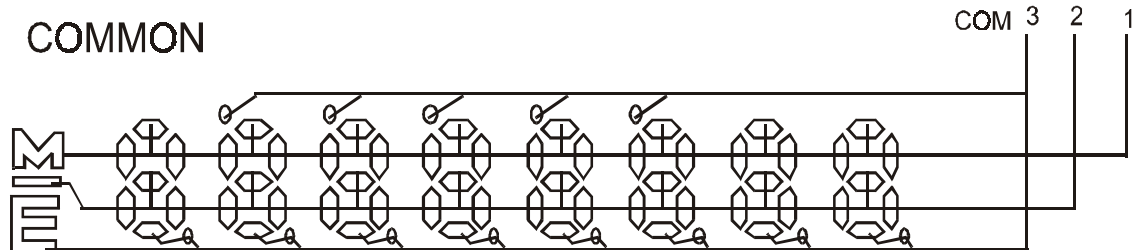

Preliminary

E) WAVEFORMS FOR DISPLAY

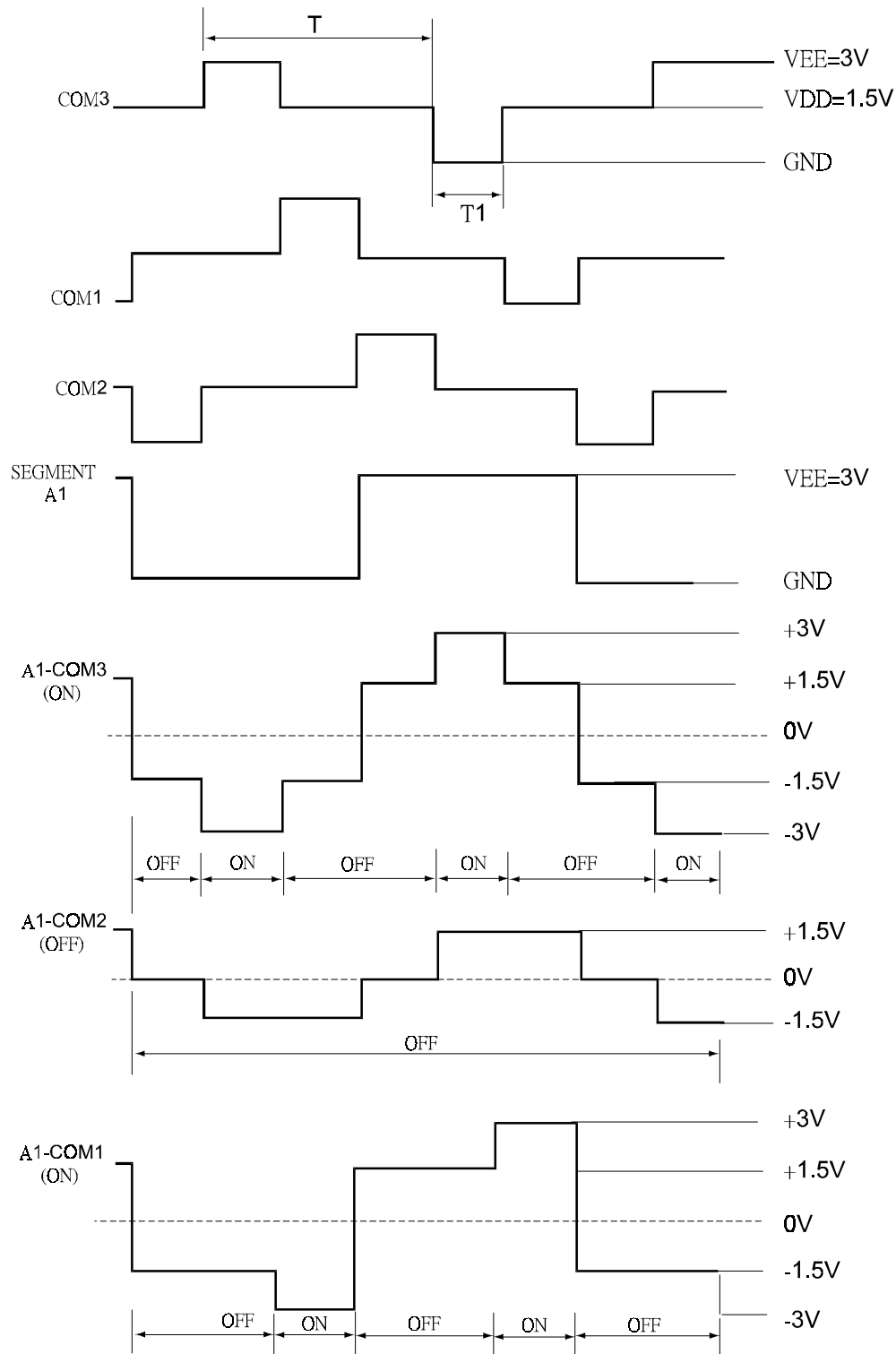

When $f_0=18\text{KHz}$, $T=1/93.8\text{ Hz}$, $T_1=3.56\text{ms}$



Preliminary

5. ABSOLUTE MAXIMUM RATINGS

Item	Sym.	Min.	Max.	Unit
Supply Voltage	VDD – VSS	-0.3	2.0	V
Input Voltage	Vin	-0.3	VDD + 0.3	V
Operating Temperature	Top	0	+ 40	°C
Storage Temperature	Tstg	-55	+ 125	°C

6. ELECTRICAL CHARACTERISTICS

(VDD=1.5V±0.2V, GND=0V, TA=25 °C, VEE=3.0±0.4V)

Parameter	Name	Sym.	Min.	Typ.	Max.	Unit	Condition
Operating Voltage	-	V _{DD}	1.2	1.5	1.8	V	
“1” Input Voltage	K3~K10 RESET	V _{IH} (1)	V _{DD} -0.4	-	V _{DD}	V	
“1” Input Voltage	K11~K12	V _{IH} (2)	V _{EE} -0.4	-	V _{EE}	V	
“0” Input Voltage	K3~K12 RESET	V _{IL}	0	-	0.4	V	
“1” Output Voltage	SEGMENT COM1~3	V _{OH} (1)	V _{EE} -0.2	-	V _{EE}	V	
“0” Output Voltage	SEGMENT COM1~3	V _{OL} (1)	0	-	0.2	V	
“M” Output Voltage	COM1~3	V _{OM}	V _{DD} -0.2	-	V _{DD} +0.2	V	
“1” Output Voltage	K1~K10	V _{OH} (2)	V _{DD} -0.2	-	V _{DD}	V	
“0” Output Voltage	K1~K12	V _{OL} (2)	0	-	0.2	V	
“1” Output Resistance	SEGMENT COM1~3	R _{OH}	-	-	70	KΩ	V _{OUT} = V _{EE} -0.5V
“0” Output Resistance	SEGMENT COM1~3	R _{OL}	-	-	70	KΩ	V _{OUT} = 0.5V



Preliminary

Parameter	Name	Sym.	Min.	Typ.	Max.	Unit	Condition
Key Pull Down Resistance	K1~K10	R _{KEYL} (1)	240	-	650	KΩ	V _{OUT} = V _{DD}
Key Pull Up Resistance	K1~10	R _{KEYH} (1)	-	-	10	KΩ	V _{OUT} = 0.5V
	RESET	R _{KEYH} (2)	50	-	370	KΩ	V _{OUT} = 0.5V
Oscillating (WAIT)		f ₀ WAIT	10.8	18.0	25.2	KHz	V _{DD} = 1.5V
Frequency (OPERATE)		f ₀ OP	57.6	96.0	134.4	KHz	V _{DD} = 1.5V
Frame Frequency	SEGMENT COM1~3	f _F	56.3	93.8	131	Hz	V _{DD} = 1.5V
Supply Current	1 (WAIT)	I _{DD} WAIT	-	2.2	3.4	μA	V _{DD} = 1.5V
	2 (OPERATE)	I _{DD} OP	-	7.0	11.0	μA	V _{DD} = 1.5V
	3 (OFF)	I _{DD} OFF	-	-	1.0	μA	V _{DD} = 1.5V
Power off Timer Times		T	429	600	1001	SEC	V _{DD} = 1.5V

Preliminary

7. APPLICATION CIRCUIT

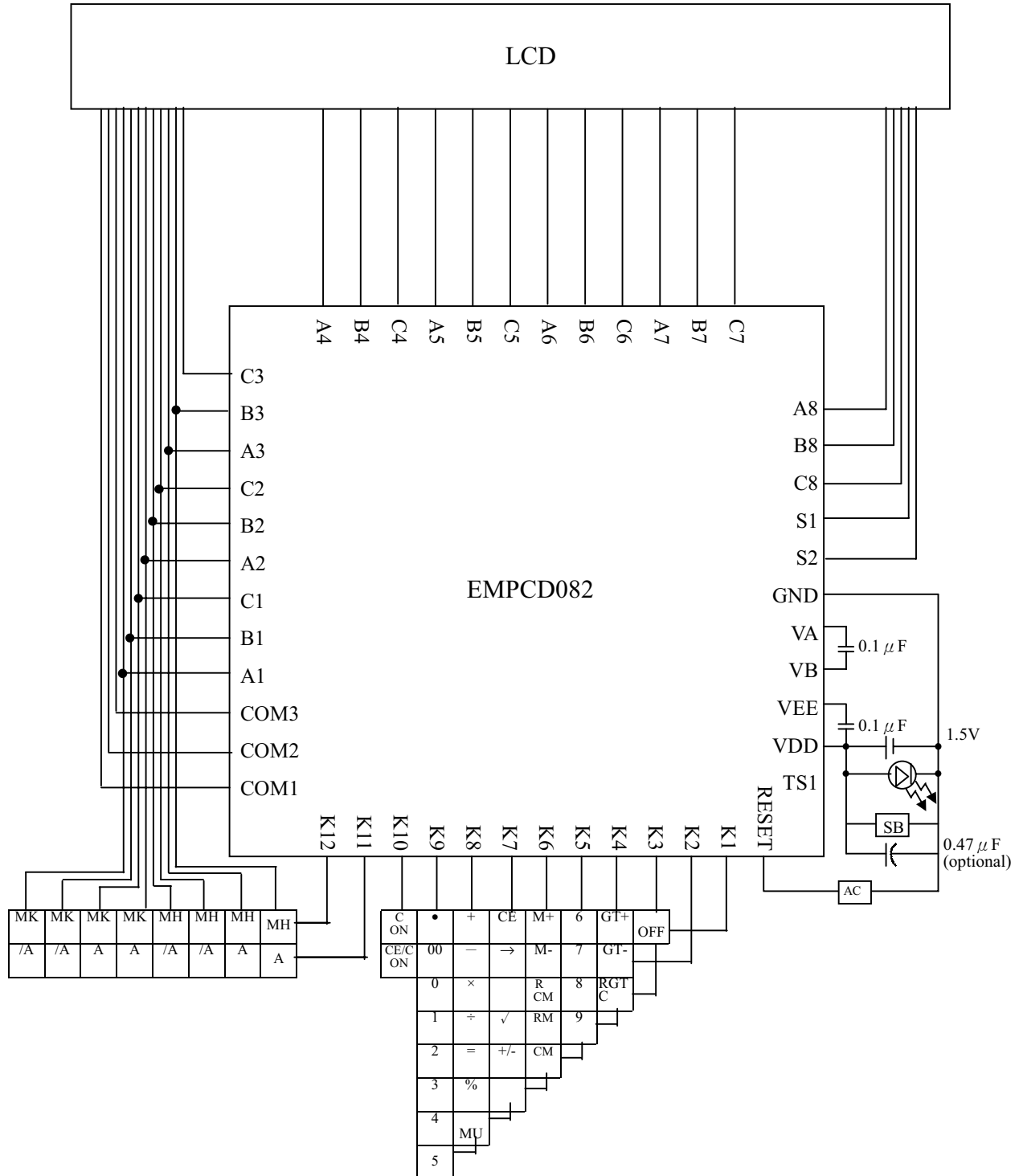



Preliminary

8. PAD DIAGRAM

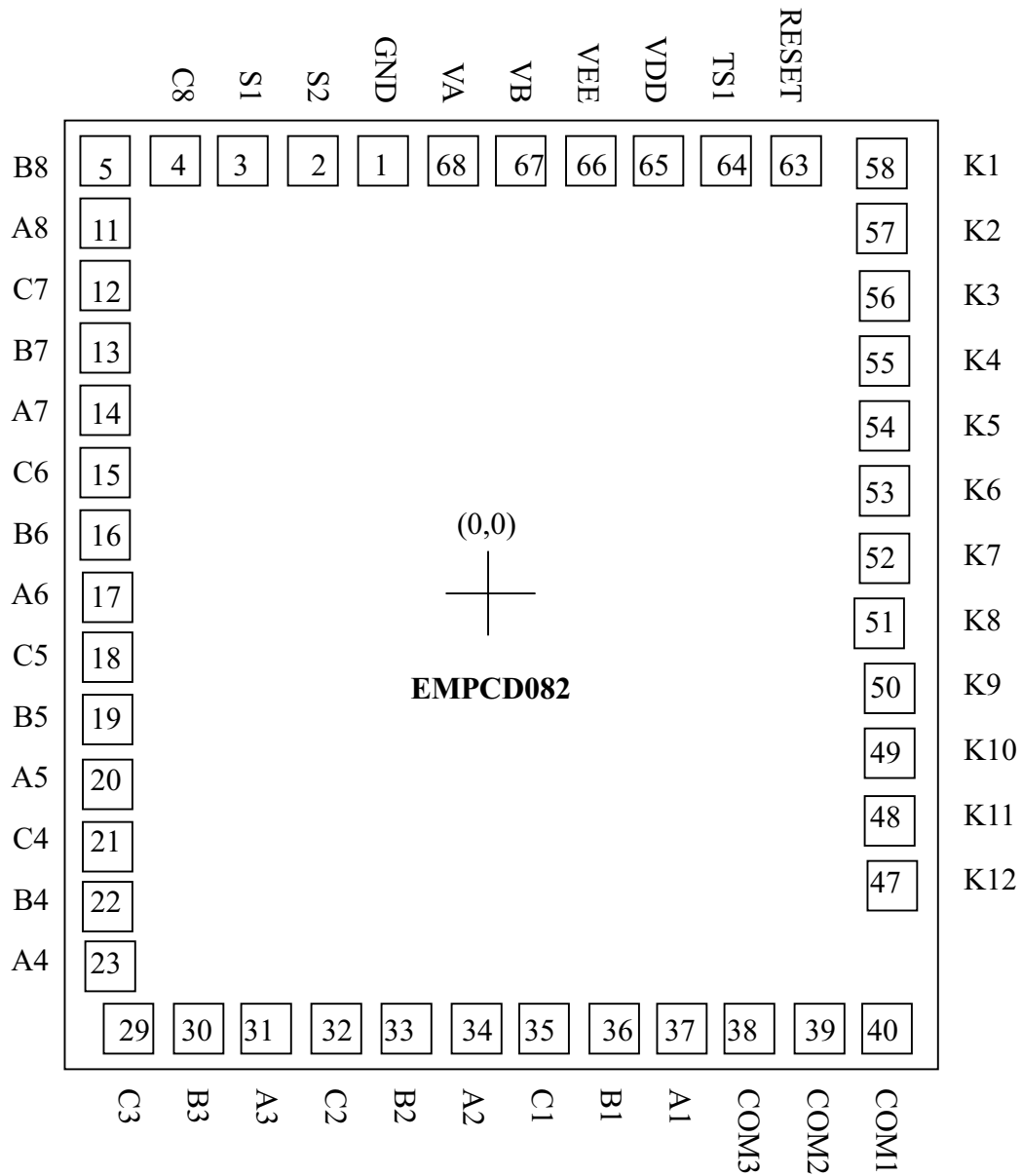



Preliminary

Pad No.	Symbol	X	Y
1	GND	-214.7	811.3
2	S2	-324.7	816.3
3	S1	-434.7	816.3
4	C8	-544.7	816.8
5	B8	-654.7	816.8
6	NC		
7	NC		
8	NC		
9	NC		
10	NC		
11	A8	-654.7	664.2
12	C7	-653.3	525.8
13	B7	-653.3	413.8
14	A7	-653.3	301.8
15	C6	-653.3	189.8
16	B6	-653.3	77.9
17	A6	-653.3	-36.7
18	C5	-653.3	-147.7
19	B5	-653.3	-258.6
20	A5	-653.3	-368.6
21	C4	-653.3	-478.6
22	B4	-653.3	-591.6
23	A4	-653.3	-702.6
24	NC		
25	NC		
26	NC		
27	NC		
28	NC		
29	C3	-619.9	-817.7
30	B3	-507.9	-817.7
31	A3	-395.9	-817.7
32	C2	-283.9	-817.7
33	B2	-166.9	-817.7
34	A2	-49.9	-817.7
35	C1	67.1	-817.7
36	B1	184.1	-817.7
37	A1	301.1	-817.7



Preliminary

Pad No.	Symbol	X	Y
38	COM3	418.1	-817.7
39	COM2	535.1	-817.7
40	COM1	652.1	-817.7
41	NC		
42	NC		
43	NC		
44	NC		
45	NC		
46	NC		
47	K12	660.1	-596.9
48	K11	653.0	-483.2
49	K10	650.5	-370.2
50	K9	650.5	-256.6
51	K8	628.8	-142.6
52	K7	642.6	-28.2
53	K6	642.6	84.3
54	K5	642.6	198.8
55	K4	642.6	311.3
56	K3	642.6	425.8
57	K2	642.6	538.3
58	K1	642.6	652.7
59	NC		
60	NC		
61	NC		
62	NC		
63	RESET	472.0	818.9
64	TS1	356.0	818.9
65	VDD	244.5	803.6
66	VEE	115.3	793.6
67	VB	5.3	811.3
68	VA	-104.7	811.3

Chip Size : 1620 * 1930 um

Note : For PCB layout, IC substrate must be connected to VSS.